

# Supply Tubing and Sound Attenuator

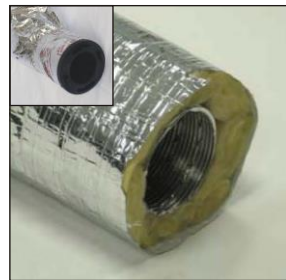

UPC-26



UPC-25

## Model Key

Unico Part Code	Type	Coupling Type	Rev.	Length	Insulation	-	Qty
UPC-	26	T	C	03	R4	-	6

Qty is either -1 or -6

Available 12 ft. (3.6 m) Models			
Size	Description	Model Number	R-Factor
2-inch (50 mm)	Aluminum Duct (supply tubing)	UPC-25T	R-3.3
		UPC-25TR4	R-4.2
		UPC-25TR6	R-6.0
		UPC-25TR8	R-8.0
	Sound Attenuator -single vapor barrier	UPC-26TC	R-3.3
		UPC-26TCR4	R-4.2
Sound Attenuator, -double vapor barrier	UPC-26TDR4	R-4.2	
	UPC-26TCR6	R-6.0	
2.5-inch (63 mm)	Aluminum Duct (supply tubing)	UPC-225	R-3.3
		UPC-225R4	R-4.2
		UPC-225R6	R-6.0
		UPC-225R8	R-8.0
	Sound Attenuator -single vapor barrier	UPC-226C	R-3.3
		UPC-226CR4	R-4.2
	Sound Attenuator, -double vapor barrier	UPC-226DR4	R-4.2
		UPC-226CR6	R-6.0
		UPC-226CR8	R-8.0

Available 3 ft. (0.9 m) Models			
Size	Description	Model Number	R-Factor
2-inch (50 mm)	Sound Attenuator -single vapor barrier	UPC-26TC03	R-3.3
		UPC-26TC03R4	R-4.2
	Sound Attenuator, -double vapor barrier	UPC-26TD03R4	R-4.2
		UPC-26TC03R6	R-6.0
		UPC-26TC03R8	R-8.0

Note: All 2-inch duct comes with Unico Twist-Fit System® Couplings pre-installed

## GENERAL

The aluminum supply tubing and sound attenuator are insulated flexible air ducts that varies by diameter, length, and insulation thickness as shown in the table on this page.

For ducts located inside the conditioned building envelope, use the standard insulation thickness (R-3.3) unless R-4.2 is required by code. For ducts located in unconditioned areas, use the higher R-factor appropriate to meet the local codes.

Note: All double vapor barrier sound attenuators meet California Title 24 and Florida requirements for porous ducts.

## APPLICATION

The Unico sound attenuator significantly reduces sound from the outlets. The aluminum supply tubing does not. For proper noise control, every duct run should be either all sound attenuator (method A, figures 1 and 2) or a combination of sound attenuator and aluminum supply tubing (method B, figures 1 and 2).

Consider using method B for long duct runs that may get damaged during installation since the aluminum duct is stronger than the sound attenuator. If using method B, use at least 3 feet (0.9 m) of the sound attenuator at the end of every supply branch run for proper sound control.

## BUILDING CODE COMPLIANCE

The sound attenuator and aluminum supply tubing are listed per UL-181 and meet the requirements of the national model building and energy codes as described in International Code Council Evaluation report [PMG-1002](#) available online at [www.icc-es.org](http://www.icc-es.org). Local codes may vary so check with your local officials for full compliance.

Use the double vapor barrier sound attenuator when required by code for porous ducts.

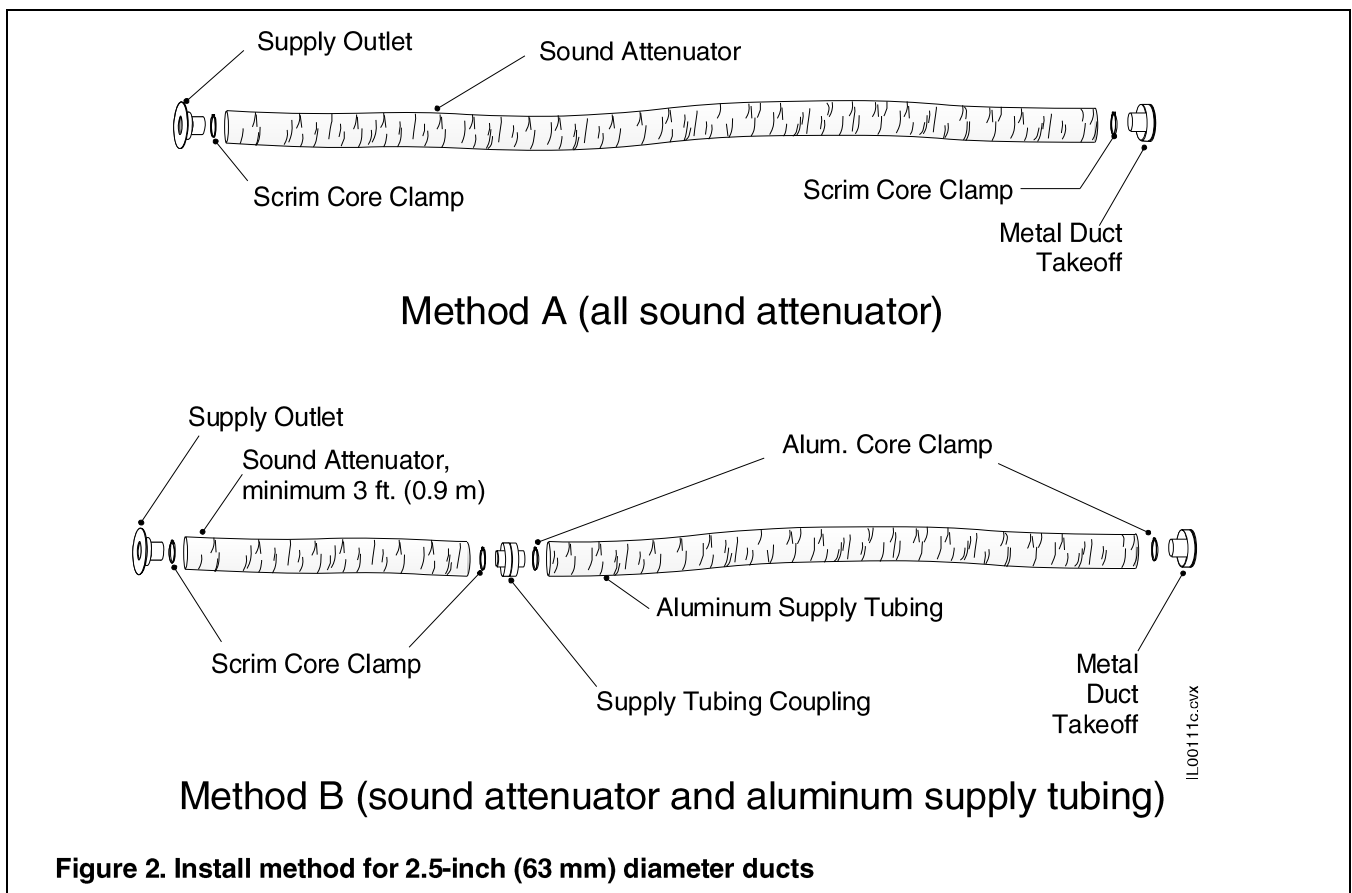
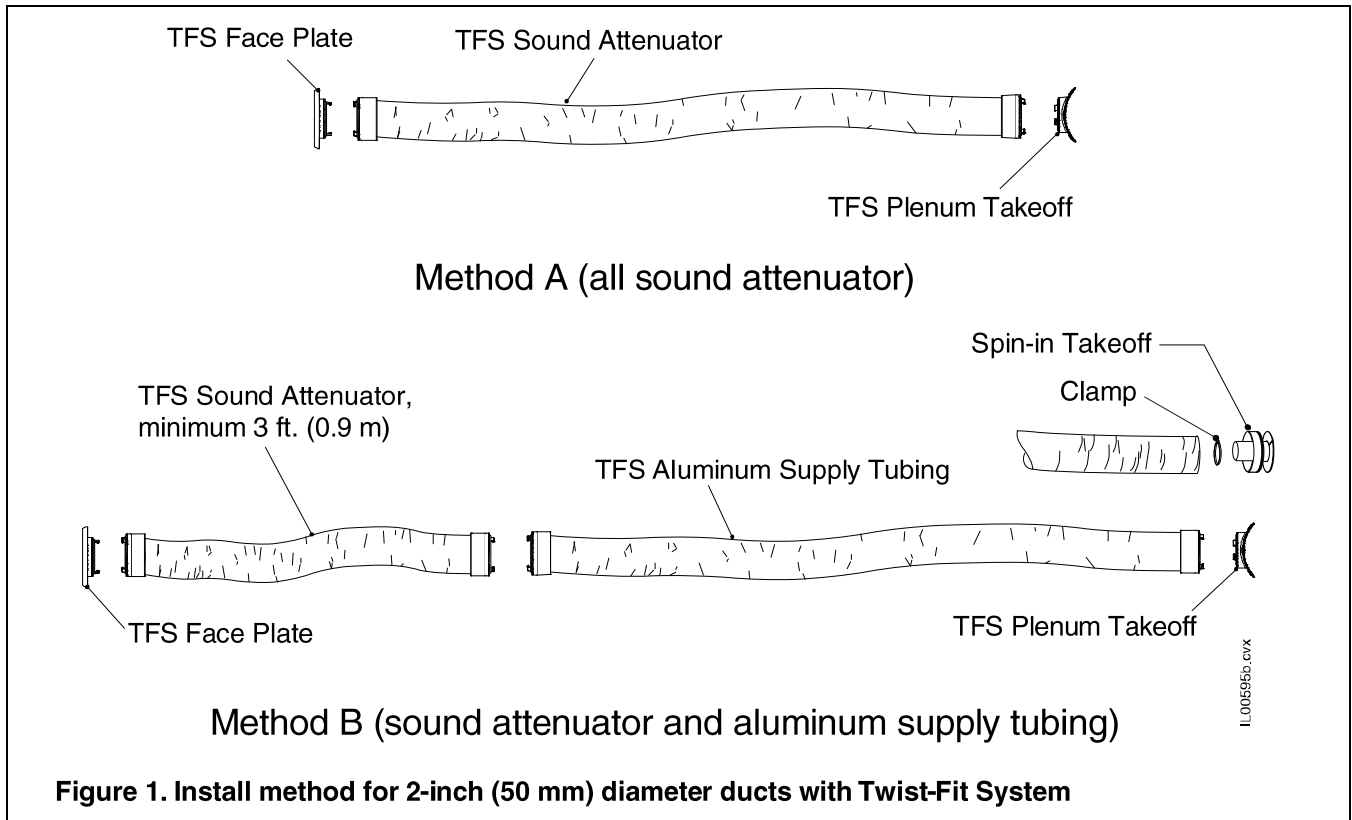

## CONSTRUCTION

The aluminum supply tubing is supplied in 25-foot (7.7-m) lengths while the sound attenuator tubing is supplied in 12-foot (3.6 m) or 3-foot (0.9 m) lengths. Both the aluminum and sound attenuator tubing can be cut as needed.

All single vapor barrier ducts (aluminum supply tubing and sound attenuator with standard insulation) are made of 3 components as shown in Figure 3.

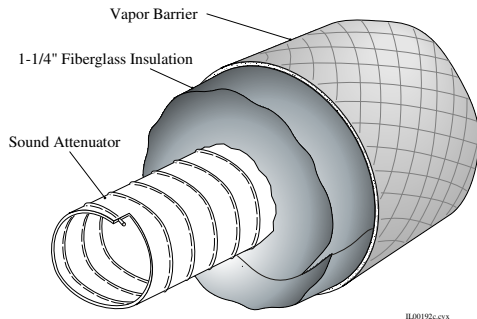

**Figure 3. Typical tubing construction**

The inner layer/core is made of two-ply corrugated aluminum for the supply tubing or spun bound nylon for the sound attenuator. The outer jacket is made of two-ply reinforced reflective Mylar™; providing a vapor seal to prevent leakage and moisture migration. The fiberglass blanket insulation fills the void between the jacket and core of the tube.

The higher R-factor (R-4, R-6, and R-8) sound attenuators are made with dual vapor barriers to reduce the chance for leakage should the outer vapor barrier get damaged (Figure 4).

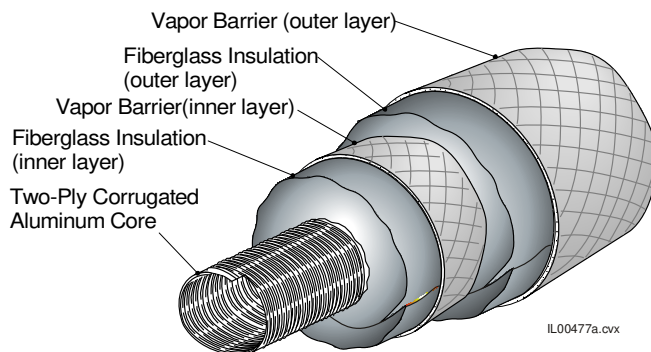

**Figure 4. Typical tubing construction with double vapor barrier**

## TWIST-FIT SYSTEM®

The 2-inch (50 mm) diameter models include the Twist-Fit System (TFS) couplings. The sound attenuators come with the connectors pre-installed on both ends for easy and fast insulation. The aluminum supply tubing comes with one TFS connector installed and one shipped loose so that the aluminum supply tubing can be cut to the exact length needed or more easily pulled through a joist space.



## DUCT HEAT GAIN/LOSS

Whenever a duct is installed in an unconditioned space, the heat gain and loss calculations must include duct loss. These are based on both thermal losses and losses due to leakage.

Small ducts are factory insulated with gasketed connections, so leakage is extremely low compared to larger ducts. Typical leakage is less than 2 percent, and often too low to measure.

Thermal losses are a combination of conduction and radiation, with conduction being the most important. Conduction heat losses are determined by R-factor, which is based on the insulation thickness and surface area. Radiant heat transfer is more important when the ducts are installed in an unconditioned space so all the Unico ducts use a reflective outer vapor barrier.

The R-factor calculation used in building codes works well for large ducts but underestimates the benefit of small ducts. This is because R-factor is calculated as if the duct wall was flat. Thermal losses should consider the curvature of the duct which is better defined using the effective R-factor (Table 1). The result is that small ducts with lower R-factor will have the same thermal losses as a large duct with a higher R-factor.

The International Residential Code (IRC) and International Energy Conservation Code (IECC) account for this by providing a different minimum R-factor for ducts less than 3-inch (76 mm) diameter. For example, R-6 is required for small ducts in unconditioned spaces, whereas, large ducts must be R-8.

**MODEL SPECIFICATIONS**

Certifications:	UL Standard 181 Flexible Air Ducts Canadian Standard CAN/ULC-S110 UK Standard BS-476-6 & 7 Fire Tests
Classification:	Air Duct per UL Standard 181 Air Duct per CAN/ULC-S110
Code Compliance	ICC IMC ICC-IRC ICC-IECC IAPMO UMC (5 ft commercial use limit) Title 24 porous duct (double vapor barrier)
Smoke Developed Rating:	less than 50
Flame Spread Index:	less than 25
Inside Diameter:	Model UPC-25/26: 2.0 inch (50 mm) Model UPC-225/226: 2.5 inch (63 mm) See Tables 2 and 3
Outside Diameter:	See Tables 2 and 3
Duct Material (supply tubing):	Two-ply corrugated aluminum
Duct Material (sound attenuator):	Spun Bound Nylon
Sound Attenuator porosity:	5 microns
Insulation:	Fiberglass
Vapor Barrier:	Reinforced Aluminized Mylar
Min. Pressure:	negative 0.5-inch w.c. (125 Pa)
Max. Pressure:	4.0 inches w.c. (1000 Pa)
Max. Velocity:	5000 ft/min (25 m/s)
Min. Length:	3 ft (1 m) <i>sound attenuator</i>
Max Length (recommended):	35 ft (10.7 m)
Max Length (code):	none
Support Distance:	every 6-ft (2 m)
Min. Inside Bend Radius:	6 inch (150 mm)
R-Factor:	See Tables 1a and 1b

**Table 1a. Duct R-Factor (English units)**

Dia.	Insulation	Outside Dia., Inch	R-factor ft <sup>2</sup> ·°F·hr/Btu	
			Rated*	Effective**
2.0 inch (50 mm)	R3	3.5	3.3	4.0
	R4	4.0	4.2	5.8
	R6	5.0	6.0	9.5
	R8	6.0	8.0	13.7
2.5 inch (53 mm)	R3	4.0	3.3	3.9
	R4	4.5	4.2	5.5
	R6	5.5	6.0	9.0
	R8	6.5	8.0	12.9

\* per ADC Flexible Duct Standard, based on flat thickness, k=24 Btu-in/h·ft<sup>2</sup>·°F  
\*\* per ASHRAE 2001 Fundamentals Handbook p. 23.21, based on curved thickness

**Table 1b. Duct R-Factor (Metric units)**

Dia.	Insulation	Outside Dia., mm	R-factor m <sup>2</sup> ·K/W	
			Rated*	Effective**
2.0 inch (50 mm)	R3	89	0.58	0.70
	R4	102	0.74	1.02
	R6	127	1.06	1.67
	R8	152	1.41	2.41
2.5 inch (53 mm)	R3	102	0.58	0.68
	R4	114	0.74	0.97
	R6	140	1.06	1.59
	R8	165	1.41	2.27

**NOISE LEVEL**

Noise level is directly related to outlet air velocity. In general, lower velocity means lower noise levels; therefore, it is easy to reduce noise by adding more outlets. Refer to Table 2 as a guide in designing a duct layout that will meet your specific sound level requirements.

**Table 2. Unico System Sound Level Recommendations**

Sound Level	Approx. dB(A) <sup>†</sup>	2-inch (50 mm)		2.5-inch (63 mm)		Recommended Application
		CFM	Outlet/Ton*	CFM	Outlet/Ton*	
Ultra Low	25	14	18	17	14	Multimedia Rooms
Very Low	27	19	13	23	11	Rooms with Hard Surfaces (wood or concrete floors and walls)
<b>Low**</b>	<b>29</b>	<b>30</b>	<b>8</b>	<b>36</b>	<b>7</b>	<b>Rooms with Carpet, Drapes, Furniture</b>
Normal	32	40	6	50	5	Large Rooms or Where Sound is not Critical (min. number of outlets)
Excessive	35	50+	5	60+	4	Industrial Environments

<sup>†</sup> dB(A) is A-weighted Sound Pressure level measured 3ft (1m) from outlet in a reverberant room 20 x 30 ft.

\* Outlets/Ton is based on rated airflow of 250 CFM per nominal cooling ton

\*\* Recommended

NOTE: The actual sound levels measured in a room will vary depending on how the duct was installed (bends, wrinkles, outlet design) and the room environment (carpeted, draperies, etc.). Also, the overall sound in the room depends on the number of outlets in that room.

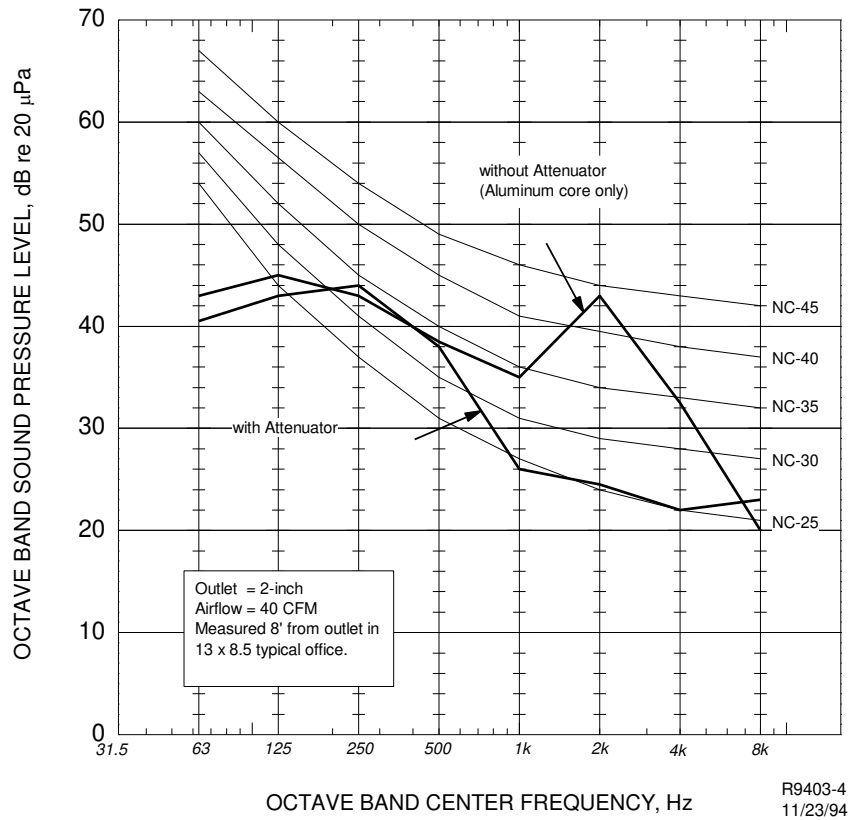

Figure 5. Sound pressure level of aluminum ducting with and without attenuation

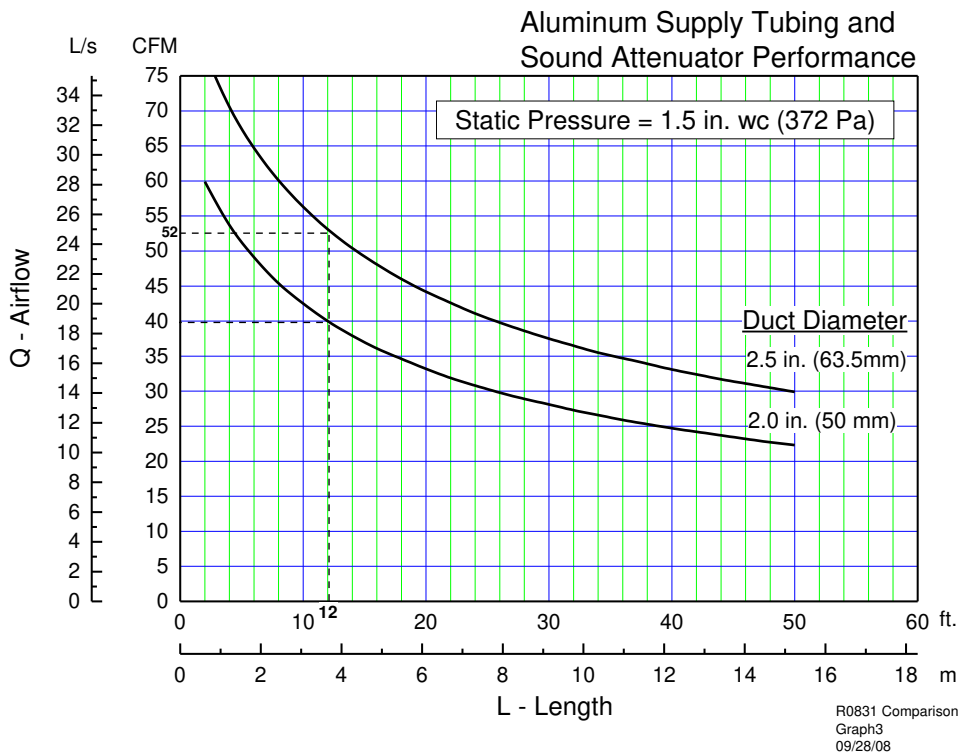

Figure 6. Comparison of airflow along length of 2-inch and 2.5-inch ducts

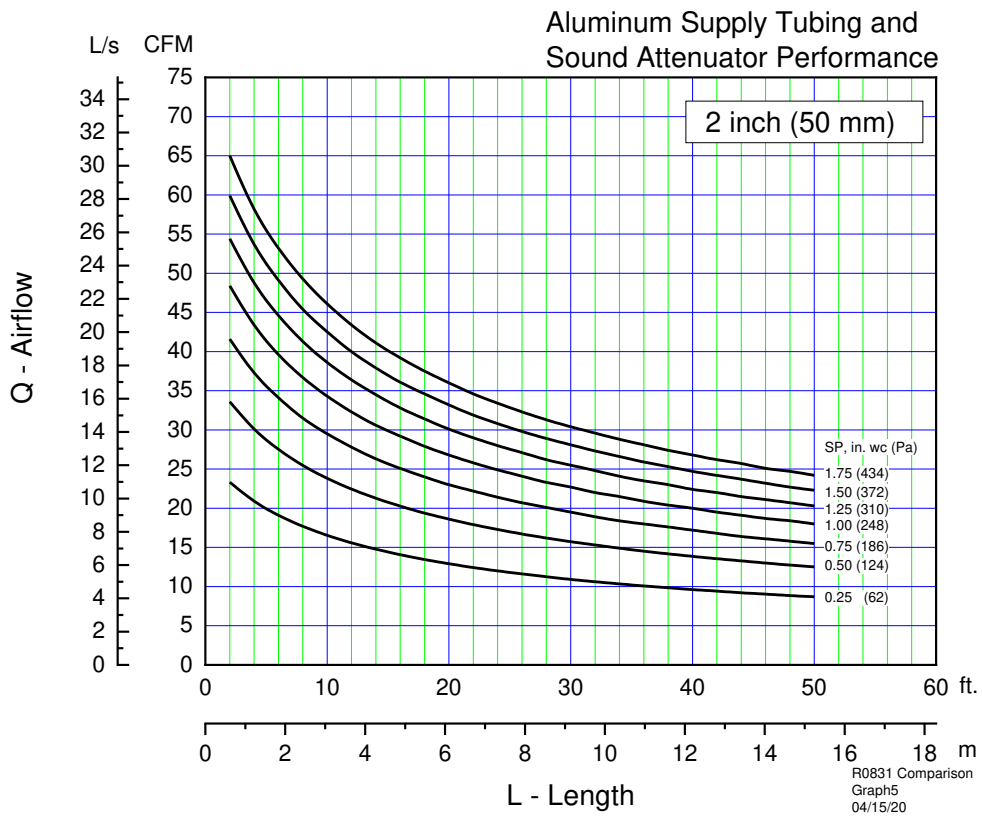

Figure 7. Variation in airflow along length of 2-inch duct at multiple static pressures

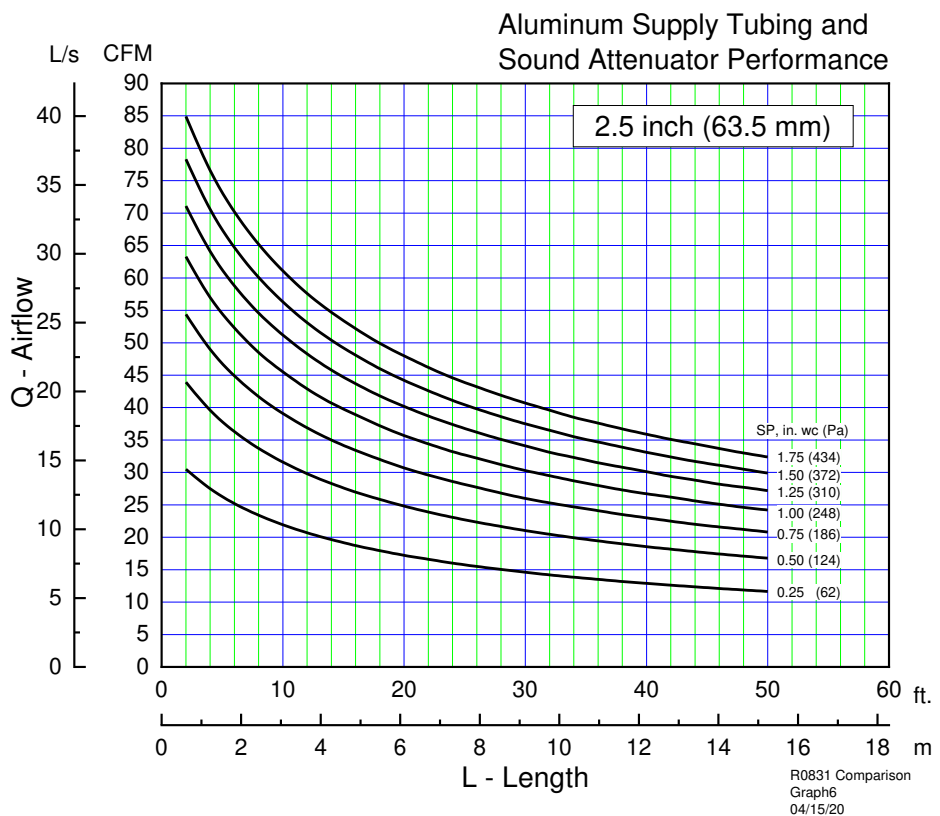

Figure 8. Variation in airflow along length of 2.5-inch duct at multiple static pressures