

Lindab **Safe and** Lindab **Safe Click**

Mounting instruction

Certified ducts and fittings

Type-approval

The Lindab Safe and the Lindab Safe Click duct system are type-approved, as per certificate no. 1105 issued by Kiwa Sverige AB and are subject to continuous production checks.

This means that the requirements for air tightness class D are met if ducts and fittings of the systems are used and if assembly is performed as per these instructions.

The products covered by the type approval are either specified on the delivery note or are supplied with the following labelling. Labelling can comprise a sticker or an embossing on the sheet metal.



NOTE! The assembly methods described herein only cope with the forces from the “Static pressure limits” defined in EN 12237. Forces from other sources, e.g. gravity or wind, have to be dealt with using other means, e.g. suspensions or supports.

NOTE! If the system shall be tested for air tightness, this shall be done **before integration and insulation** so that there is an opportunity for inspection and taking action. Any complaints regarding air tightness will **only** be dealt with provided the system is fully accessible for inspection.

Eurovent certification

Lindab’s circular duct system with rubber gasket connections Lindab Safe and Lindab Safe Click is certified to strength and leakage in tightness class D according to the Eurovent Certified Performance program for circular metallic ducts systems (DUCT-MC 17.11.002).



Lindab products that are Eurovent certified have the Eurovent logotype in the footer of the technical documentation.

Note: Most Lindab Safe and Lindab Safe Click and the most commonly used product in a ventilation system are essentially better than class D, however some products are according to EN 15727 not class D as a single product. These products are stated in the documentation as Class C and can be used in D class systems to a limited extension.

Joining systems (general characteristics)

Lindab Safe	Lindab Safe Click
Is joined with screws or blind rivets.	Is joined with snapping heels, below called notches. Is based on Lindab Safe.
Spans all dimensions.	Spans only a restricted number of dimensions. See table 2. For the other dimensions use Lindab Safe.
	<p>Lindab Safe Click can be complementary joined with screws or blind rivets.</p> <p>This may be done in order to:</p> <ul style="list-style-type: none"> • achieve a stronger joint • prevent a joint from twisting • join a Click product with a non-Click product • join a Click product with a non-Click product to create an openable joint.

Preparations for assembly

- Check that ducts and fittings to be used in the system are labelled as shown above.
- Store ducts and fittings in a well-ordered and weatherproof storage area to minimize the risk of damage. Do not use ducts or fittings that have been damaged in such a way that they jeopardise the air tightness or structural strength of the system.

Lindab Safe	Lindab Safe Click
<ul style="list-style-type: none"> • Cut ducts at right angles. Carefully remove any burrs from cut edges. Installation is easier and the risk of damaging the gasket is reduced if there are no burrs. Also cut away the two needles created from the fold. 	<ul style="list-style-type: none"> • Cut ducts at right angles. This is an uncompromisable demand for Lindab Safe Click. Carefully remove any burrs from cut edges. Installation is easier and the risk of damaging the gasket is reduced if there are no burrs. Also cut away the two needles created from the fold.
	<ul style="list-style-type: none"> • If a duct is cut – make notches around its circumference. See table 1 and 2.
<ul style="list-style-type: none"> • Carefully seal any holes left by measurements, removed screws, blind rivets, etc. 	<ul style="list-style-type: none"> • Carefully seal any holes left by measurements etc.

Table 1. Size and location of notches

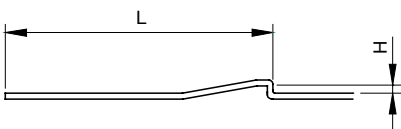





	Click Pliers		L [mm]
	40.1	60.1	
			
Ø [mm]	Hmin [mm]	Hmin [mm]	L [mm]
80–224	2,0	–	30,5–32,5
250–315	–	2,5	50,5–52,5

Table 2. Number of fasteners and notches

	Lindab Safe	Lindab Safe Click	
		Click Pliers	
		40.1 	60.1 
Ø [mm]	Minimum number of fasteners required to achieve sufficient strength.		
63	2	–	–
80–112	2	2	–
125–160	3	4	–
180–224	3	4	–
250–315	4	–	4
355–630	4	–	–
710–1250	6	–	–
1400–1600	10	–	–
	Depending on the means of suspension, a larger number of fasteners than this may be required to achieve sufficient structural strength of a duct system.	Depending on the means of suspension, a larger number of notches than this may be required to achieve sufficient structural strength of a duct system. A greater number of notches makes it harder to assemble the parts.	

Assembly

Lindab Safe	Lindab Safe Click
1 Insert the fitting's turned-over edge into the duct.	1 Insert the fitting's turned-over edge into the duct.
2 Check that the gasket's first lip is in contact with the duct's edge all the way around and points straight out so that the lip is not twisted in any direction.	2 Check that the gasket's first lip is in contact with the duct's edge all the way around and points straight out so that the lip is not twisted in any direction.
3 Push the rest of the fitting into the duct. Twisting the fitting slightly aids insertion.	3 Push the first part of the fitting into the duct to just before the notches. Twisting the fitting slightly aids insertion.
4 Secure the fitting in the duct using self-tapping screws or airtight blind rivets. NOTE! Use only the types allowed by Lindab when going for tightness class C or D. See table 3.	4 Push the rest of the fitting into the duct and over the notches. Bend the fitting or duct back and forward slightly in order not to pass all notches at the same time aids insertion.
5 Fasteners should be positioned 10–15 mm from the duct's end to prevent damage to the gasket.	5 The fitting is secured to the duct when the fitting's end has snapped behind all the notches.
6 Always position fasteners at the present largest radial gap between fitting and duct. Be sure to achieve an even distribution around the circumference.	6 After assembly it's possible to rotate the fitting.

Lindab Safe

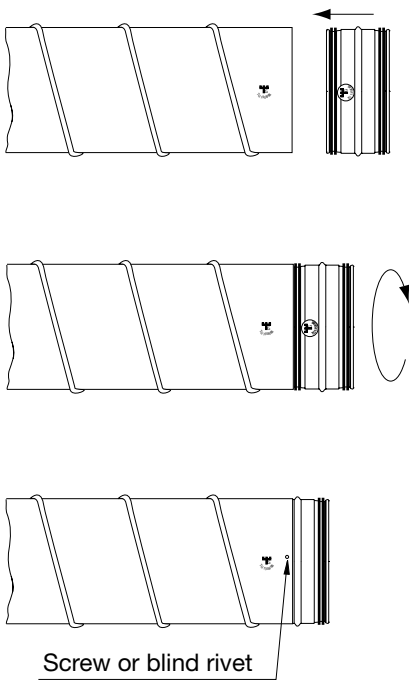

Lindab Safe Click

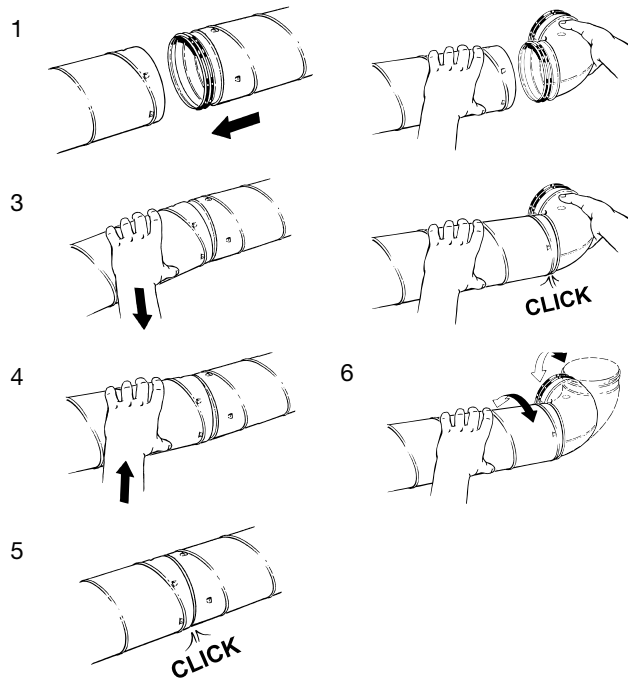
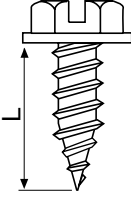
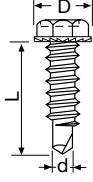
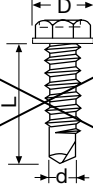

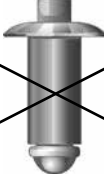

Table 3. Allowed and banned screws and blind rivets

	<p>Screw with sharp tip</p> <ul style="list-style-type: none"> • Very tight • Strong since it forms a collar in the thin sheet metal 	<p>Allowed by Lindab</p>
	<p>Screw with reduced drill tip</p> <ul style="list-style-type: none"> • Very tight • Strong since it only drills off a small part of the thin sheet metal 	<p>Allowed by Lindab</p>
	<p>Screw with drill tip</p> <ul style="list-style-type: none"> • Not tight • Weak since it drills off a big part of the thin sheet metal 	<p>Banned by Lindab</p>
	<p>Pressure-tight blind rivet</p> <ul style="list-style-type: none"> • Very tight • Strong • Very laborious to install 	<p>Allowed by Lindab</p>
	<p>Blind rivet</p> <ul style="list-style-type: none"> • Not tight if the inner splint falls out • Strong • Laborious to install 	<p>Banned by Lindab</p>

Hints!

Turning and bending the fitting slightly as you insert it into the duct aids assembly and removal.

If ducts and fittings are round, assembly is much easier. Lindab has placed high demands on roundness during the design and production stages, but large heavy fittings in particular have a tendency to be slightly oval because of their weight. These often become round when suspended, which is why you should use the brackets to make the components round and in this way simplify assembly.

Carefully tapping the surface of the duct with your hand normally makes assembly a lot easier, as it reduces the friction between duct and fitting, and the fitting tries to move to the right side if there are burrs and irregularities.

When cutting, be sure to remove burrs properly. Also cut away the two needles created from the fold.

For larger dimensions, Lindab has moved the gasket away from the edge, which makes assembly much easier.

If you have to reinstall a product, take care to seal old holes from screws or blind rivets which can cause leaks and noise.

Products with special seals

Some fittings, such as the collar saddle PSU, T-pieces TSTCU, TSTU and take-offs ILRU, ILU, ILF, have one more connection than Lindab Safe or Lindab Safe Click. This connection must be sealed so that they definitely meet the requirements for air-tightness class C or D. Sealing material used must be durable and permanently elastic.

Products without Click

Some fittings, such as the slide-in female coupling SMFU, the end caps EPF and ESU and of course the cleaning covers EPFH, ESHU, KCU and KCIVU, do not have any Click function in order to make them easier to remove.

Use of products other than Lindab Safe or Lindab Safe Click

Products that do not formally fulfil the requirements for air tightness class C or D may only be used to a small extent. If such items are used, they must be carefully checked with regard to seal design and strength. They must be sealed so that they definitely meet the requirements for air-tightness class C or D. Sealing material used must be durable and permanently elastic.

To join parts temporarily to check if length of duct or system run is all right.	
Lindab Safe	Lindab Safe Click
<p>Solution:</p> <ol style="list-style-type: none"> 1 Join together to check. 2 Then take apart – and cut if necessary the duct length. 3 Join together with screws or blind rivets. 	<p>Solution 1:</p> <ol style="list-style-type: none"> 1 Use a duct without notches in the end/ends. 2 Join together to check. 3 Then take apart – and cut if necessary the duct length. 4 Make notches in the duct. 5 Click-join together. <p>Solution 2:</p> <ol style="list-style-type: none"> 1 Use a duct with notches in the end/ends. 2 Join together to check – but don't join the parts completely so they click together. 3 Then take apart – and cut if necessary the duct length and make new notches. 4 Click-join together.

Lindab Safe Click

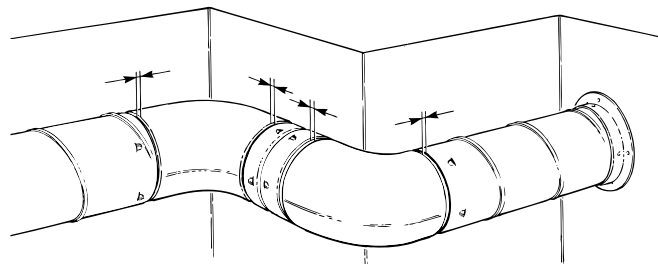

To lengthwise adjust joined products instead of cutting the duct.	
Lindab Safe	Lindab Safe Click
<p>Solution:</p> <ol style="list-style-type: none"> 1 Use products with sliding property. E.g. slide-in coupling SNPU or slide-in female coupling SMFU. 2 Join together with screws or blind rivets. 	<p>Solution:</p> <ol style="list-style-type: none"> 1 Use products with sliding property. E.g. slide-in coupling SNPU or slide-in female coupling SMFU. 2 Join together with screws or blind rivets.

Slide-in coupling

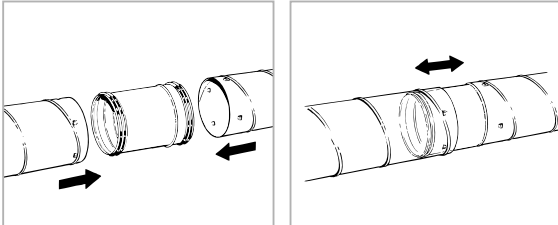

The joint must be locked

Slide-in female coupling

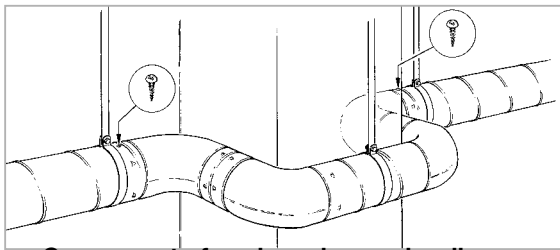
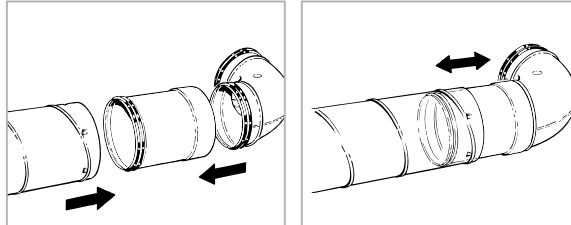

Corners out of angle and curved walls

In situations where the mounting must be locked, e.g. when a bend is mounted to a duct and it twists downwards the floor. Mount the first hanger and mount the bend, then lock the joint with a screw or blind rivet.

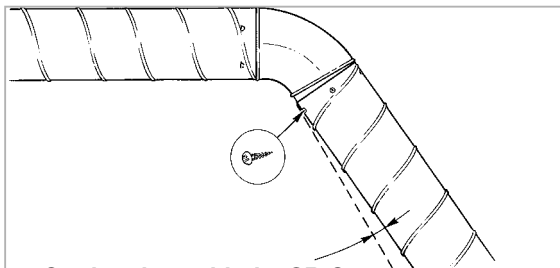

Cutting duct with the SR Cutter

Mount the next piece of duct at an angle, but make sure that the rubber sealant is not visible. Put screws or blind rivets where the notches have not clicked in position.

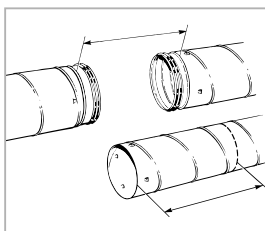

Suspension

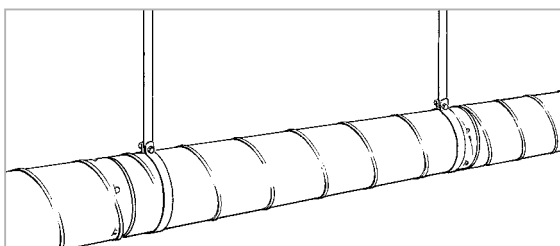
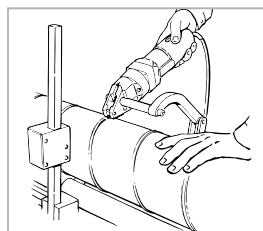
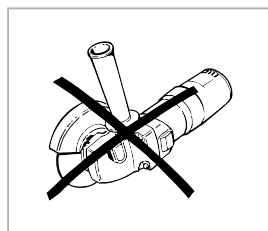

Mount the hangers in a straight line and as close to every joint as possible. Fix with an extra screw when needed for extra stability.

Dismantling

To separate joined products.	
Lindab Safe	Lindab Safe Click
<p>Solution:</p> <ol style="list-style-type: none"> 1 Unscrew the screws or drill away the blind rivets. 2 Twist the product loose. 3 The fitting will now have leaking holes but can be reused if these holes are carefully sealed off with mastic or tape. 	<p>Solution:</p> <ol style="list-style-type: none"> 1 Drill a 5 mm hole in the duct 4 mm behind the notch with the drill angled backward and 2 turn in the same moment the drill back so the fitting and duct are separated somewhat from each other. With the right technique the fitting remains undamaged and can be reused. 3 Repeat if necessary at more notches. 4 Twist the product loose. 5 Cut away the drilled through duct end.

Lindab Safe Click

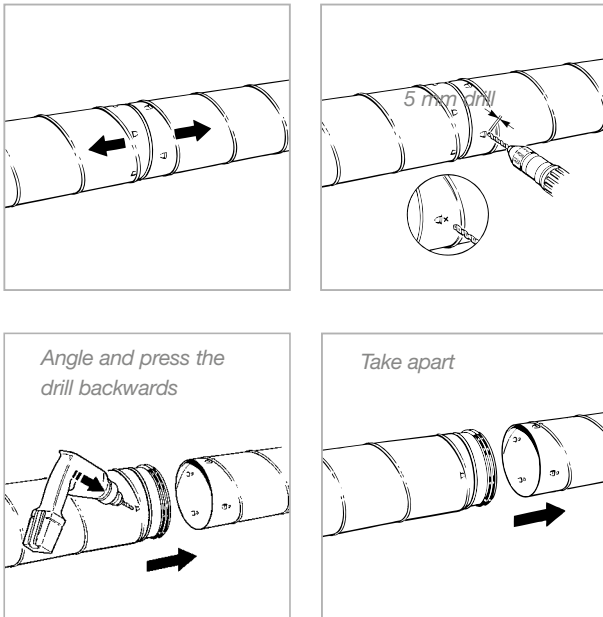



Good Thinking

At Lindab, good thinking is a philosophy that guides us in everything we do. We have made it our mission to create a healthy indoor climate – and to simplify the construction of sustainable buildings. We do that by designing innovative products and solutions that are easy to use, as well as offering efficient availability and logistics. We are also working on ways to reduce our impact on our environment and climate. We do that by developing methods to produce our solutions using a minimum of energy and natural resources, and by reducing negative effects on the environment. We use steel in our products. It's one of few materials that can be recycled an infinite number of times without losing any of its properties. That means less carbon emissions in nature and less energy wasted.

We simplify construction